



- 10 The table below shows the rental fees for skates.

Skates for Rent		
First hour	\$10 per pair	
Every additional $\frac{1}{2}$ hour	\$6 per pair	

Cedelle rented a pair of skates from 10 am to 12 noon. How much did she pay?

- (1) \$16
(2) \$20
(3) \$22
(4) \$32
- 11 A number when divided by 10 gives a remainder of 7. Which of the following can be added to the number to change it to a multiple of 5?
- (1) 5
(2) 2
(3) 3
(4) 4
- 12 Mr Lim had \$100. He bought 2 crabs which cost \$30.50 each and some fishes which cost \$23.70. How much money had he left?
- (1) \$15.30
(2) \$45.80
(3) \$84.70
(4) \$184.70



**Rosyth School
Preliminary Examination 2020
Mathematics
Paper 1
Primary 6**

Name: _____ Register No. _____

Class: Pr 6 - _____

Date: 25 August 2020 Parent's Signature: _____

Total Time for Booklets A and B : 1 hour

Booklet A

Instructions to Pupils:

1. Do not open this booklet until you are told to do so.
2. Follow all instructions carefully.
3. Shade your answers in the Optical Answer Sheet (OAS) provided.
4. You are **not** allowed to use a calculator.
5. Answer all questions.

Section	Maximum Mark	Marks Obtained
Paper 1 (Booklet A)	20	

* This booklet consists of 8 pages (including this cover page).



Questions 1 to 10 carry 1 mark each. Questions 11 to 15 carry 2 marks each.
For each question, four options are given. One of them is the correct answer.
Make your choice (1, 2, 3 or 4). Shade the oval (1, 2, 3 or 4) on the Optical Answer Sheet.

All diagrams in this paper are not drawn to scale unless stated otherwise.

(20 marks)

1 Round off 80 282 to the nearest tenth.

- (1) 80
- (2) 80.2
- (3) 80.3
- (4) 80.28

2 Express $6 + 10f - 4 + 2f$ in the simplest form.

- (1) $12f + 2$
- (2) $12f + 10$
- (3) $14f - 4$
- (4) $18f - 4$

3 The average amount of money saved by Annie and Ben was \$36. Annie saved three times as much as Ben. How much did Ben save?

- (1) \$ 9
- (2) \$18
- (3) \$54
- (4) \$72



4. What is the length of the pencil in the figure below?

- (1) 5.2 cm
- (2) 5.4 cm
- (3) 5.8 cm
- (4) 6.0 cm

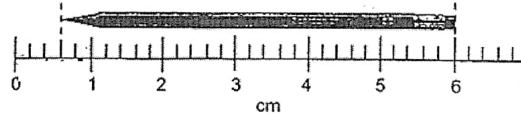

5. What is the possible mass of the watermelon in the figure below?

- (1) 6.5 g
- (2) 65 g
- (3) 6.5 kg
- (4) 65 kg



6. Weng is facing East.
He turns 225° in a clockwise direction.
He then turns 45° in an anti-clockwise direction.
Which direction is he facing now?

- (1) North
- (2) South
- (3) East
- (4) West



7 Which two lines are perpendicular to each other?

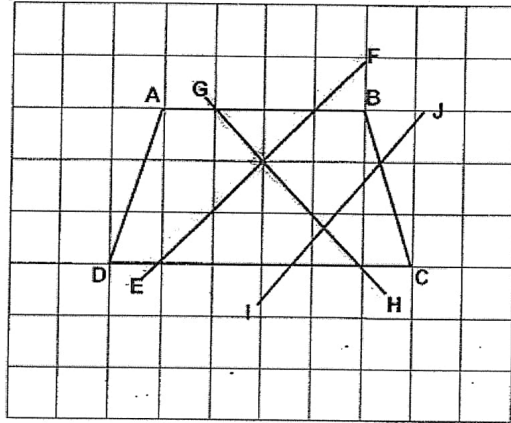

- (1) AB and CD
- (2) GH and IJ
- (3) EF and IJ
- (4) GH and EF



- 8 In the figure below, ABCD is a trapezium. EDC is a straight line. AB is parallel to DC. Find $\angle DAB$.

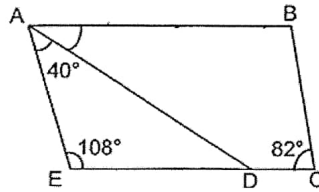

- (1) 22°
(2) 32°
(3) 42°
(4) 68°
- 9 The figure below is made up of 3 straight lines. Find $\angle w$.

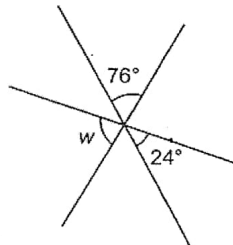

- (1) 66°
(2) 80°
(3) 100°
(4) 104°



13 Mdm Rosie sold only roses on Mother's Day. She sold 200 stalks of them in the morning and $\frac{2}{5}$ of the remainder in the afternoon. After that, she had $\frac{1}{2}$ of the roses left. How many stalks of roses did she sell in the afternoon ?

- (1) 400
- (2) 600
- (3) 1000
- (4) 1200

14 The figure below is made up of 4 identical circles inside a square. The length of the square is 28 cm. Find the perimeter of the shaded part. (Take $\pi = \frac{22}{7}$)

- (1) 88 cm
- (2) 102 cm
- (3) 116 cm
- (4) 144 cm

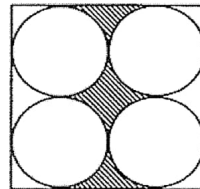



- 15 A survey was conducted to find out the favourite snack of a group of 50 children. They could only pick one type of snack and each type was picked by at least one child.

The table below showed the results of the survey. Given that the most popular snack is Mamee Monster and the least popular snack was prawn crackers, what was the greatest number of children who picked Potato chips ?

Favourite snacks

Mamee Monster	Potato Chips	Prawn Crackers	Chocolates
24	?	3	

- (1) 19
- (2) 23
- (3) 27
- (4) 4



**Rosyth School
Preliminary Examination 2020
Mathematics
Paper 1
Primary 6**

Name: _____

Register No. _____

Class: Pr 6 - _____

Group No.: _____

Date: 25 August 2020

Parent's Signature: _____

Total Time for Booklets A and B : 1 hour

Booklet B

Instructions to Pupils:

1. Do not open this booklet until you are told to do so.
2. Follow all instructions carefully.
3. You are not allowed to use a calculator.
4. Write your answers in the booklet.
5. Answer all questions.

Section	Maximum Mark	Marks Obtained
Paper 1 (Booklet B)	25	

* This booklet consists of 9 pages (including this cover page).



Questions 16 to 20 carry 1 mark each. Write your answers in the spaces provided. For questions which require units, give your answers in the units stated.

Do not write in this space

All diagrams in this paper are not drawn to scale unless stated otherwise.

(5 marks)

16 List all the common factors of 20 and 35.

Ans : _____

17 Express 3.2 as a percentage.

Ans : _____ %

18 At a carnival, 215 toys were sold in 4 days.
How many toys were sold on Tuesday?

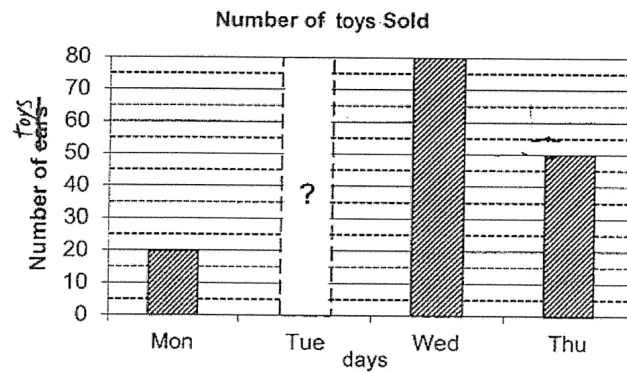

Ans : _____



- 19 The figure below shows a solid that is made up of 1-cm cubes. Find the volume of the solid.

Do not write
in this space

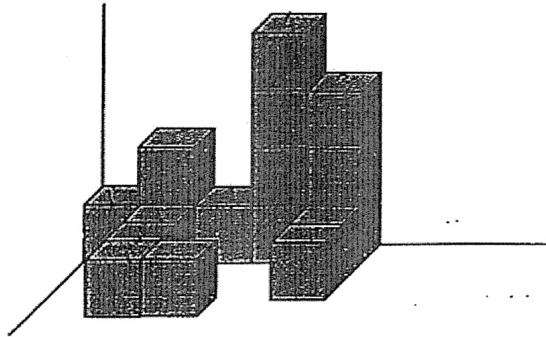

Ans : _____ cm³

- 20 Complete symmetric figure below with PQ as the line of symmetry.

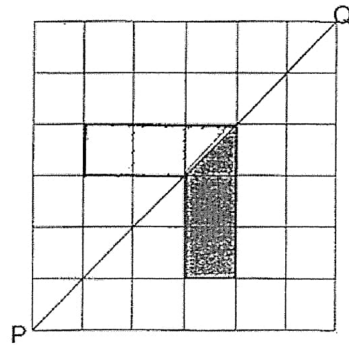



Questions 21 to 30 carry 2 marks each. Show your workings clearly in the space provided for each question and write your answers in the spaces provided. For questions which require units, give your answers in the units stated.

Do not write
in this space

All diagrams in this paper are not drawn to scale unless stated otherwise.

(20 marks)

- 21 Find the value of $7 \div 8$. Give your answer correct to 2 decimal places.

Ans : _____

- 22 The figure below, not drawn to scale, is formed using 2 identical squares, 2 identical large equilateral triangles and 2 identical small equilateral triangles. The length of the square is 15 cm. Find the perimeter of the figure.

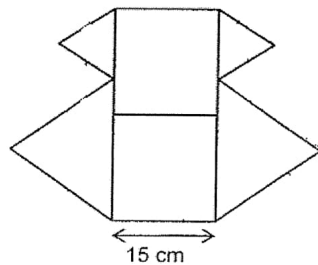

Ans : _____ cm

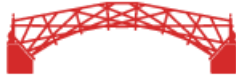

- 23 Nicole had some sugar.
She used $\frac{1}{5}$ kg of the sugar to make cupcakes and $\frac{1}{3}$ of the sugar to make jelly. She had 140 g of sugar left. How many grams of sugar did Nicole have at first?

Do not write in this space

Ans : _____ g

- 24 ABCD and DEFA are identical trapeziums. $AG=GO=OH=HD$. What fraction of the figure is shaded? Leave your answer in the simplest form.

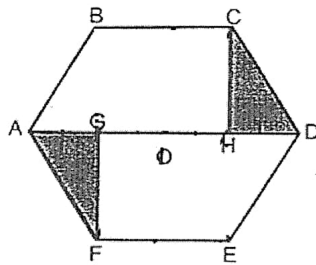

Ans : _____

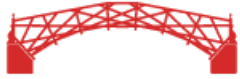

- 25 Bridget is 12 years old now. Her cousin is y years younger than her. Find their combined age 5 years later in terms of y .

Do not write
in this space

Ans : _____

- 26 The table below shows the month of April in one year. Mr Osman plans to attend a course 38 days after 12 April. Which day will he be attending the course?

April						
Sun	Mon	Tue	Wed	Thu	Fri	Sat
3	4	5	6	7	1	2
10	11	12	13	14	15	16
17	18	19	20	21	22	23
24	25	26	27	28	29	30

Ans : _____



- 27 James cuts out a square and a triangle from a rectangular strip of paper as shown below. Square ABCD has an area of 81cm^2 . Square ABCD has same the perimeter as Triangle XYZ. XY is 12 cm and XZ is 14 cm. Find the area of Triangle XYZ.

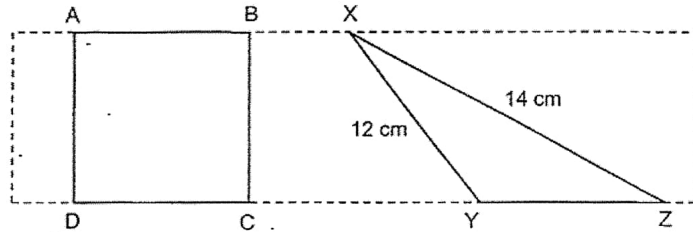

Do not write
in this space

Ans : _____ cm^2



Do not write
in this space



- 28 In the square grid, PQ is a straight line.
PQ forms one side of a rhombus PQRS.
Complete the drawing of the rhombus PQRS. Label the points R and S.

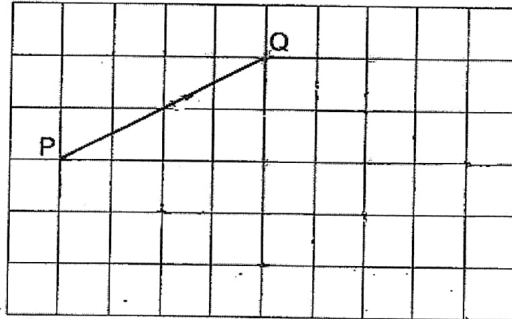

- 29 The figure below is made up of a parallelogram ABOE and a trapezium BCDO. $\angle EAB = 112^\circ$ and $\angle OBC = 138^\circ$. Find $\angle EOD$.

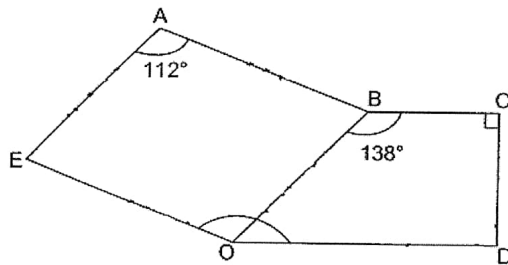

Ans : _____°

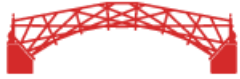

30 At a carnival, 5 boys played darts at 2 stations from 9 a.m. to 10.30 a.m. At any time, 2 of them played while the other 3 boys watched. If each of them had the same amount of time playing darts, how many minutes did each boy play the game?

Do not write
in this space

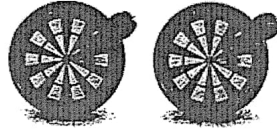

Ans : _____ min

End of paper
Have you checked your work?



Rosyth School
Preliminary Examination 2020
Mathematics
Paper 2
Primary 6

Name: _____

Register No. _____

Class: Pr 6 - _____

Group No: _____

Date: 25 August 2020

Parent's Signature: _____

Time: 1 h 30 min

Instructions to Pupils:

1. Do not open this booklet until you are told to do so.
2. Follow all instructions carefully.
3. **Show your workings clearly** as marks are awarded for correct working.
4. Write your answers in this booklet.
5. You are allowed to use a calculator.
6. Answer all questions.

Questions	Maximum Mark	Marks Obtained
Q 1 to 5	10	
Q 6 to 17	45	

Section	Maximum Mark	Marks Obtained
Paper 1	45	
Paper 2	55	
Total	100	



Questions 1 to 5 carry 2 marks each. Show your working clearly in the space provided for each question and write your answers in the spaces provided. For questions which require units, give your answers in the units stated.

(10 marks)

All diagrams in this paper are not drawn to scale unless stated otherwise.

Do not write in this space

1. Uncle Bob sells bubble tea at \$6.30 per cup of 700 ml. He only sells one size of bubble tea at his stall. Uncle Bob wants to make \$1000 a day. What is the minimum number of cups he must sell?

Ans : _____

2. Miss Lee bought $\frac{8}{9}$ kg of butter. $\frac{1}{3}$ kg of butter was needed to bake a cake. She wanted to bake the greatest possible number of cakes.

Each of the statements below is either true, false or not possible to tell from the information given. For each statement, put a tick (\checkmark) to indicate your answer.

Statement	True	False	Not possible to tell
The greatest number of cakes Miss Lee could bake was 2.			
After baking, Miss Lee had $\frac{2}{3}$ kg of butter left.			



3. The solid below is made up of 11 cubes.

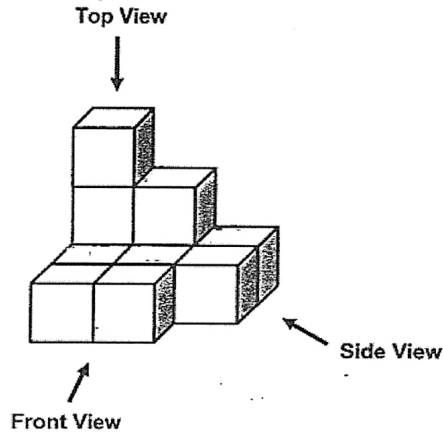

Do not write in this space

(a) Draw the side view of the solid on the grid below.

Side View

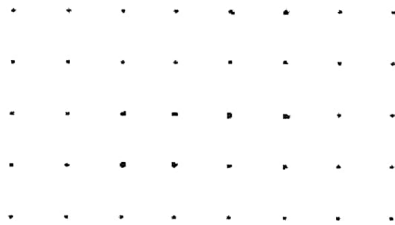

(b) Norah painted the whole solid including the base. Then she took it apart into its 11 cubes. How many of the cubes have 2 of the faces painted?

Ans : _____





4. The diagram below is drawn to scale. Use a protractor to find $\angle a$.

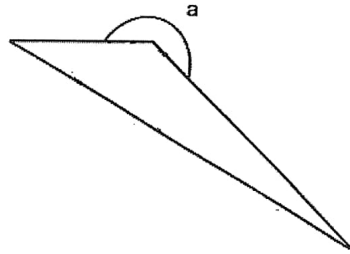

Ans : _____ °

Do not
write in
this
space

5. There are two numbers. One is 3 times the other. They have exactly four common factors. Three of the common factors are 1, 3 and 7. What are the two numbers?

Ans : _____ and _____

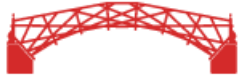

For Questions 6 to 17, show your working clearly in the space provided for each question and write your answers in the spaces provided. The number of marks available is shown in brackets [] at the end of each question or part-question. For questions which require units, give your answers in the units stated.

(45 marks)

All diagrams in this paper are not drawn to scale unless stated otherwise.

Do not
write in
this
space

6. A sum of money was shared among three girls, Maggie, Alice and Cecilia. Maggie received \$ m . Alice received twice as much money as Maggie. Cecilia received \$55 less than Alice.

- (a) Express the amount of Cecilia's money in terms of m .
(b) If $m = 35$, find the total sum of money shared by the three girls.

Ans : (a) _____ [1]

(b) _____ [2]





7. Mr Chan bought some pots of plants at \$15 each. He also bought an equal number of identical bags of soil for the plants. The average price of a pot of plant and a bag of soil was \$12.50. Mr Chan paid \$45 less for the bags of soil than the plants. How much did he spend on the plants?

Do not
write in
this
space

Ans : _____ [3]



8. The figure below, not drawn to scale, is made up of a circle and a right-angled triangle XYZ. $XY = YZ$. XY is 20 cm. YZ is the diameter of the circle. Find the area of the shaded part. (Take $\pi = 3.14$)

Do not write in this space

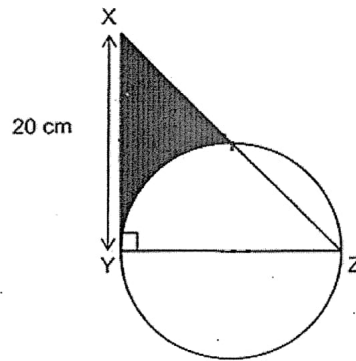

Ans : _____ [3]





9. A rectangular tank measuring 60 cm long by 15 cm wide by 40 cm high was $\frac{1}{3}$ filled with water at first. Devi filled 4 identical bottles with water to the brim. Then she poured all of the water from the bottles into the rectangular tank and the tank became $\frac{3}{4}$ full. What was the capacity of each bottle?

Do not write in this space

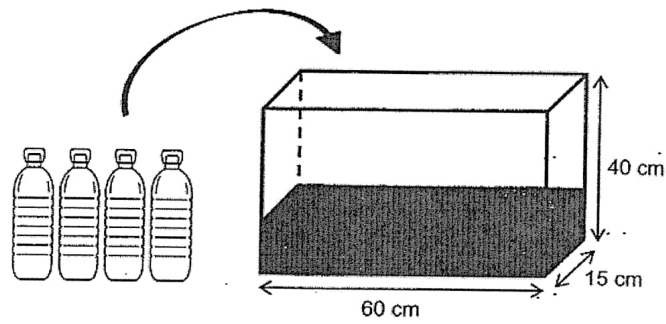

Ans : _____ [3]



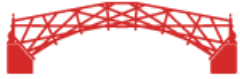

10. The figure is made up of a rectangle ABCD and 2 identical squares DEFG and HIJF. EJ and HG are straight lines. Find $\angle p$.

Do not write in this space

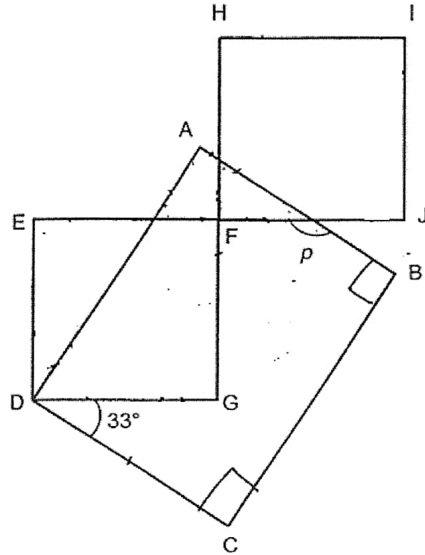

Ans : _____ [3]





11. Alex and Benjamin were each given some stickers. Alex had four times as many stickers as Benjamin. After Alex gave away 203 stickers and Benjamin gave away 26 stickers, Benjamin had three times as many stickers left as Alex. How many more stickers did Alex have than Benjamin at first ?

Do not
write in
this
space

Ans : _____ [4]



12. Mel has a total of 648 black and white buttons. He has 360 more black buttons than white buttons. He puts all the black buttons equally into empty black boxes and puts all the white buttons equally into empty white boxes. There are thrice as many black boxes as white boxes. Each black box contains 4 more buttons than each white box. How many buttons are there in each white box?

Do not
write in
this
space

Ans : _____ [4]



13. The graph shows the number of visitors to the museum from January to June.

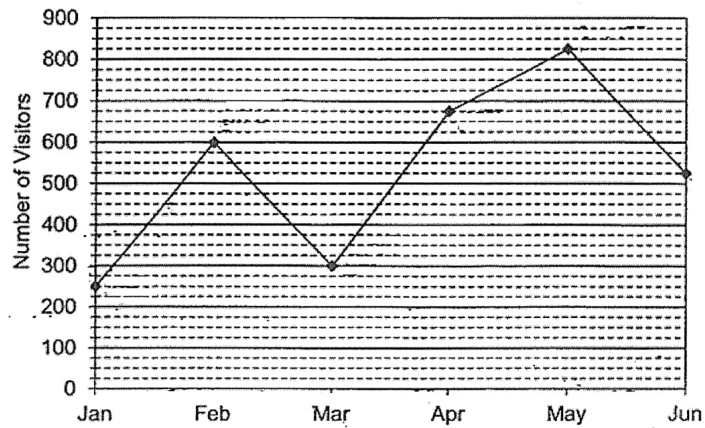

Do not write in this space

- a) In which one-month period was there the greatest change in the number of visitors to the museum ?
- b) In month of June, for every adult visitor, two visitors were children. How many visitors were children in June?
- c) From January to February what was the percentage increase in the number of visitors to the meseum ?

Ans : a) Between _____ and _____ [1]

b) _____ [1]

c) _____ [2]





14. The figure below shows a rectangle and 11 identical shaded circles. Each shaded circle is in contact with those next to it. The rectangle has a perimeter of 384 cm.

Do not write in this space

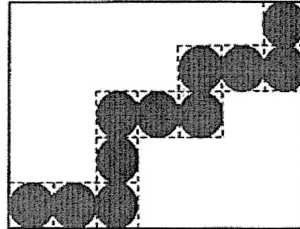

- a) Find the radius of one circle.
- b) More identical shaded circles are added. The whole rectangle is then covered with a maximum number of shaded circles. Find the area of the rectangle that is not covered by the shaded circles.
(Take $\pi = \frac{22}{7}$)

Ans : a) _____ [1]

b) _____ [3]





15. The figure below is made up of a right-angled triangle ABE and two isosceles triangles ACF and CDF. $AC = FC$ and $DF = DC$. Find $\angle ABC$.

Do not write in this space

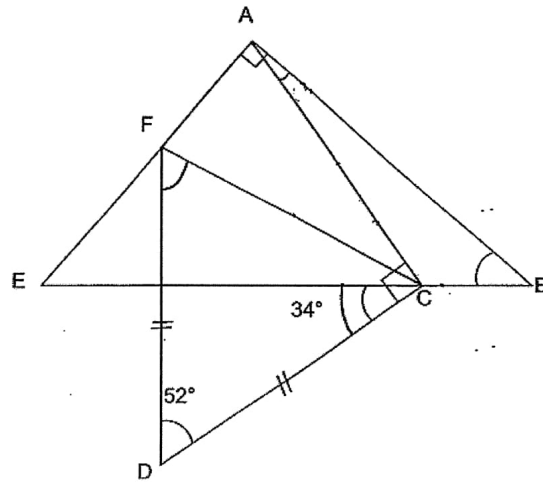

Ans : _____ [4]





16. Yanti decorated the sides of a rectangular board with 16 buttons. The buttons were placed at an equal distance apart along all the sides of the board. The length of the board was 210 cm. The figure below shows part of her layout.

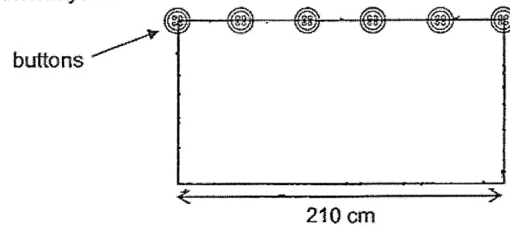

- a) What was the breadth of the rectangular board?
- b) After that, Yanti decided to use a combination of ribbons and buttons. She spent $\frac{1}{4}$ of her money on 16 buttons and 4 ribbons. The cost of each ribbon is twice the cost of each button. Yanti bought some more ribbons with $\frac{1}{2}$ of her remaining money. How many ribbons did she buy altogether in the end ?

Do not write in this space

Ans : a) _____ [2]

b) _____ [3]





17. Mdm Yap sold some T-shirts in March. The table below shows the number of T-shirts sold for size S and L but not size M and XL.

Size of T-shirt	Number of T-shirt
S	80
M	?
L	400
XL	?

- (a) 50% of the T-shirt were in size L. The ratio of the number of T-shirt in size M to size XL is 5 : 11. How many of the T-shirts were in size M?
- (b) Mdm Yap sold all of her T-shirts in the size of S at the usual price and all of her T-shirts in size M at a discount of 25%. She received a total of \$1620 from the sale. The amount of money she received from the sale of the T-shirt in size M was \$180 more than the sale of T-shirt in size S. What is the price difference in the cost of a T-shirt in size S and a T-shirt in size M at their usual price?

Do not
write in
this
space

Ans : a) _____ [2]

b) _____ [3]



End of paper
Have you checked your work?



SCHOOL : ROSYTH PRIMARY SCHOOL
LEVEL : PRIMARY 6
SUBJECT : MATH
TERM : 2020 PRELIM

PAPER 1 BOOKLET A

Q 1	Q2	Q3	Q4	Q5	Q6	Q7	Q8	Q9	Q10
3	1	2	2	3	4	4	2	2	3

Q 11	Q12	Q13	Q14	Q15
3	1	1	3	1

PAPER 1 BOOKLET B

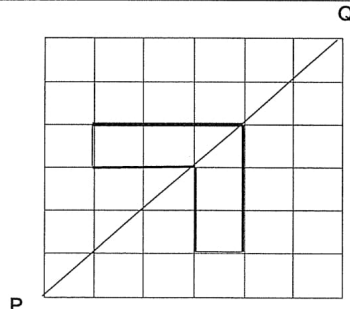
Q16)	1, 5
Q17)	320%
Q18)	65
Q19)	17 cm ³
Q20)	
Q21)	0.88
Q22)	150cm
Q23)	510g
Q24)	$\frac{1}{6}$

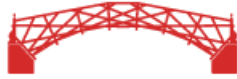

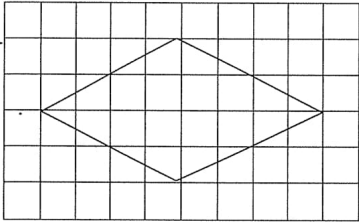
Q25)	$(34 - y)$
Q26)	Fri
Q27)	45cm ²
Q28)	
Q29)	154°
Q30)	36 min

PAPER 2

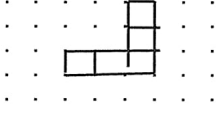
Q1)	$\$1000 \div \$6.30 = 158 \text{ R } \$460$ $158 + 1 = 159$
Q2)	True False
Q3)	a)  b)2
Q4)	$a = 360 - 135 = 225^\circ$
Q5)	21 and 63
Q6)	$A \text{---} 2 \times \$m = \$(2m)$ $C \text{---} \$(2m) - \$55 = \$(2m - 55)$ $\$35 + \$(2 \times 35) + \$(2 \times 35 - 55)$ $= \$120$

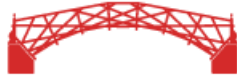

Q7)	$\$12.50 \times 2 + \25 $\$25 - \$15 = \$10$ $\$15 - \$10 = \$5$ $\$45 \div 5 = 9$ $9 \times \$15 = 135$
Q8)	$r = 20\text{cm} \div 2 = 10\text{cm}$ area of 1  $\frac{1}{2} \times 10 \times 10 \times 3.14 = 78.5$ $\frac{1}{2} \times 10 \text{ cm} \times 10\text{cm} = 50\text{cm}^2$ $\frac{1}{2} \times 20\text{cm} \times 20\text{cm} = 200\text{cm}^2$ $200\text{cm}^2 - 50\text{cm}^2 - 78.5\text{cm}^2$ $= 71.5\text{cm}^2$
Q9)	$\frac{5}{12} \times 40 \times 15 \times 60 = 15000$ $15000 \div 4 = 3750\text{ml}$
Q10)	$ADG = 90 - 33 = 57$ $EDA = 90 - 57 = 33$ $X = 180 - 90 - 33 = 57$ $P = 57 + 90^\circ$
Q11)	$12u - 609 = 1u - 26$ $11u = 583 \div 11 = 53$ $4u - 1u = 3u$ $3u = 3 \times 53 = 159$
Q12)	$540 \div 3 = 168$ $168 - 144 = 24$ $24 \div 4 = 6$ $144 \div 6 = 24$
Q13)	a) Mar and Apr b) 350 c) 140%
Q14)	a) 8cm b) 1920cm ²
Q15)	43°

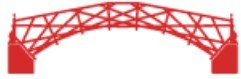

Q16)	a)126cm b)22
Q17)	a)100 b)\$3