



Questions 16 to 20 carry 1 mark each. Write your answers in the spaces provided.
For questions which require units, give your answers in the units stated. All diagrams are not drawn to scale.

16. Find the value of $480 \div (3 + 5) \times 2$.

Ans: _____

17. Arrange the following numbers from the smallest to the largest.

4.09, 40.03, 4.106, 40.007

Ans: _____, _____, _____, _____
(Largest)

18. Express $\frac{7}{9}$ as a decimal. Round your answer to 1 decimal place.

Ans: _____



**RAFFLES GIRLS' PRIMARY SCHOOL
SEMESTRAL ASSESSMENT 1
MATHEMATICS (PAPER 1)
PRIMARY 5**

Name: _____ ()

Form Class: P5 _____

Math Teacher: _____

Date: 14 May 2019

Duration: 1 hour

Your Paper 1 Score (Out of 45 marks)	
Your Paper 2 Score (Out of 55 marks)	
Your Total Score (Out of 100 marks)	
Parent's Signature	

INSTRUCTIONS TO CANDIDATES

1. Do not turn over this page until you are told to do so.
2. Follow all instructions carefully.
3. Answer **ALL** questions and show all working clearly.
4. **NO** calculator is allowed for this paper.



Questions 1 to 10 carry 1 mark each. Questions 11 to 15 carry 2 marks each.
For each question, four options are given. One of them is the correct answer.
Make your choice (1, 2, 3 or 4). Shade your answer (1, 2, 3 or 4) on the OAS provided.
All diagrams are not drawn to scale.

1. In 87 304, what does the digit 7 stand for?

- (1) 700
- (2) 7000
- (3) 70 000
- (4) 700 000

2. Find the number in the blank.

$$706\ 000 \div 200 = \underline{\hspace{2cm}}$$

- (1) 353
- (2) 3530
- (3) 35 300
- (4) 353 000

3. 13 tens, 4 hundredths and 7 thousandths is the same as _____.

- (1) 1.347
- (2) 13.047
- (3) 130.47
- (4) 130.047

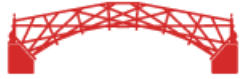

4. Express 0.45 as a fraction in its simplest form.

(1) $\frac{9}{20}$

(2) $\frac{9}{200}$

(3) $\frac{45}{100}$

(4) $\frac{45}{1000}$

5. $\frac{6}{7} \times \frac{14}{9} = \underline{\hspace{2cm}}$

Leave your answer in its simplest form.

(1) $\frac{1}{3}$

(2) $\frac{7}{9}$

(3) $\frac{12}{9}$

(4) $1\frac{1}{3}$



6. Find the volume of the cuboid.

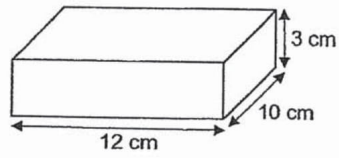

- (1) 25 cm^3
- (2) 30 cm^3
- (3) 120 cm^3
- (4) 360 cm^3

7. Find the area of triangle ACD.

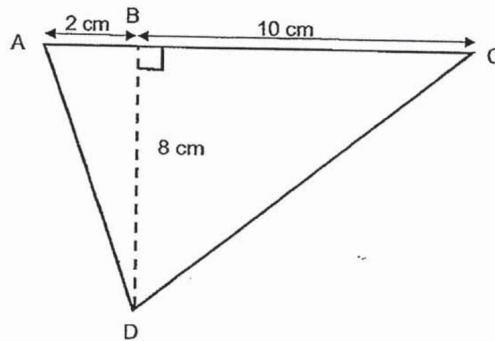

- (1) 16 cm^2
- (2) 48 cm^2
- (3) 80 cm^2
- (4) 96 cm^2



8. The figure shows an 8-point compass. Miriam was standing at X. After turning 225° in an anti-clockwise direction, Miriam faced the park. Where was Miriam facing before the turn?

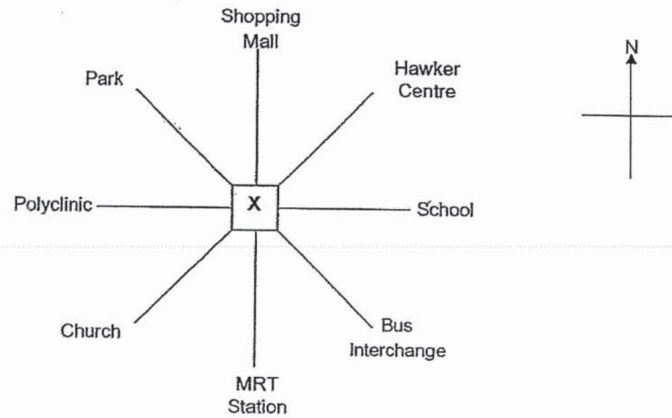

- (1) School
(2) Church
(3) MRT Station
(4) Hawker Centre
9. Which of the following pairs of letters are both symmetric?

S T A N

- (1) A and N
(2) A and T
(3) S and N
(4) S and T



10. What is the missing number in the box?

$$32 : 48 = 12 : \square$$

(1) 6

(2) 8

(3) 18

(4) 28

11. A small bell tolls once every 6 minutes and a large bell tolls once every 8 minutes. If they toll together at 12 p.m., at what time will the two bells next toll together again?

(1) 12.14 p.m.

(2) 12.18 p.m.

(3) 12.24 p.m.

(4) 12.48 p.m.

12. A sum of \$450 was shared among 10 boys and 12 girls. Each girl received \$15. How much did each boy get?

(1) \$25

(2) \$27

(3) \$30

(4) \$45



13. The table shows the number of pupils who went to school by train, car and bus.

	Train	Car	Bus
Girls	45	63	?
Boys	66	54	25

The total number of boys who went to school by train and car was three times the total number of pupils who went to school by bus. How many girls went to school by bus?

- (1) 11
- (2) 15
- (3) 40
- (4) 51
14. Sabrina bought 9 packets of sweets at \$3.80 each and 15 mini chocolate bars at 3 for \$1.50. How much did she pay for all the items?
- (1) \$34.20
- (2) \$38.70
- (3) \$41.70
- (4) \$56.70
15. Every day, Ross cycles to school which is $1\frac{7}{8}$ km away from his home. After school, he cycles home along the same route. What is the total distance Ross cycles from Monday to Friday?
- (1) $1\frac{3}{4}$ km
- (2) $4\frac{3}{8}$ km
- (3) $6\frac{1}{8}$ km
- (4) $8\frac{3}{4}$ km

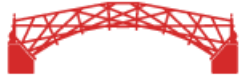

19. Shade 3 more squares to complete the symmetric figure with AB as the line of symmetry.

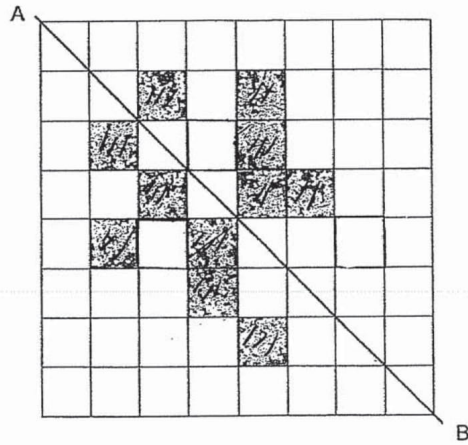

20. Find the value of $\frac{3}{8} \times \frac{2}{4}$. Leave your answer in its simplest form.

Ans: _____



Questions 21 to 30 carry 2 marks each. Show your working clearly in the space provided for each question and write your answers in the spaces provided. For questions which require units, give your answers in the units stated. All diagrams are not drawn to scale.

21. 10 muffins were shared equally among Phoebe and her 3 cousins. How many muffins did each child receive? Express your answer as a mixed number in its simplest form.

Ans: _____

22. A solid is made up of some identical cubes. The volume of each cube is 8 cm^3 . What is the volume of the solid?

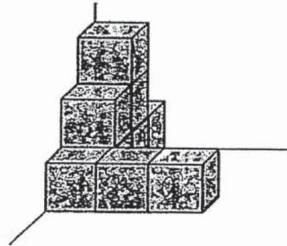

Ans: _____ cm^3



23. Mr Chun bought 2 rulers and 9 pens for \$21.60. The cost of 2 rulers was the same as the cost of 3 pens. What was the cost of 1 ruler?

Ans: \$ _____

24. Ali, Xiaoli and Bali had a total of 105 stamps. Ali had twice as many stamps as Xiaoli and Bali had twice as many stamps as Ali. How many stamps did Bali have?

Ans: _____



25. Fandi had 6 times as much money as Tong Lim at first. After Fandi spent \$99.10 and Tong Lim received \$310.90 from his father, they had an equal amount of money. How much money did they have altogether at first?

Ans: \$ _____

26. Find the total area of the shaded parts.

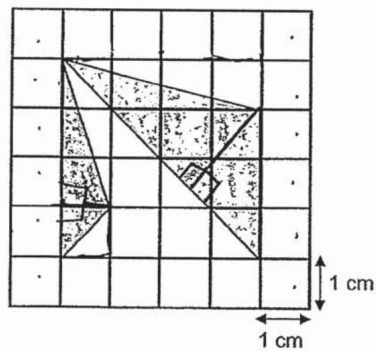

Ans: _____ cm²



27. The bar graph shows the number of tickets sold for a choir performance from Tuesday to Saturday.

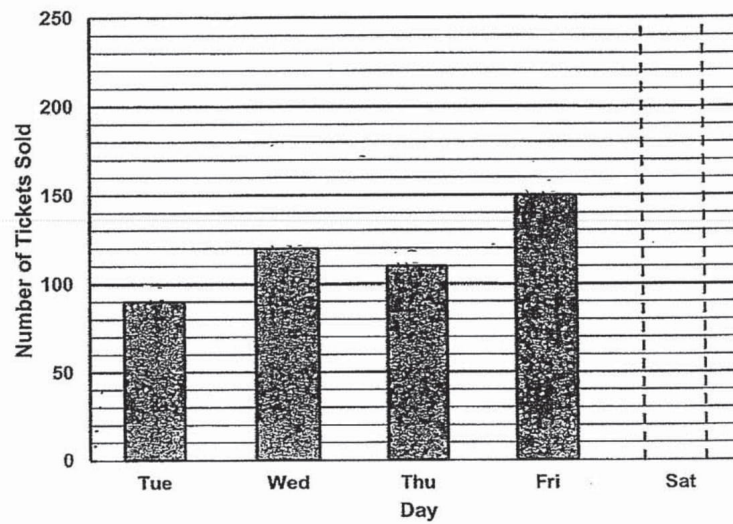

Each ticket for the choir performance cost \$40 on a weekday and \$50 on weekends. A total amount of \$17 000 was collected for the tickets sold on Friday and Saturday. How many tickets were sold for the choir performance on Saturday?

Ans: _____

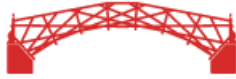

28. Monica had 68 stamps and Chandler had 40 stamps. Monica gave 24 of her stamps to Chandler. What was the ratio of the number of Monica's stamps to the number of Chandler's stamps in the end?
Leave your answer in its simplest form.

Ans: _____

29. The diagram shows an empty rectangular tank with a square base. The height of the tank is 20 cm and its length is half of its height. After all the water in a big container and a small container was poured into the tank, the tank became $\frac{3}{4}$ full. What was the volume of water in the small container at first?

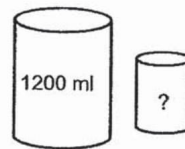
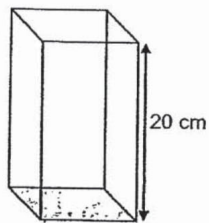

Ans: _____ cm³



30. There were 70 more male than female at a concert. There was an equal number of boys and girls. The number of women was $\frac{2}{9}$ the number of adults.

Based on the information above, put a tick in the correct box.

	True	False	Impossible to tell
a) There were 90 men at the concert.			
b) There were more adults than children at the concert.			

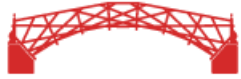

**RAFFLES GIRLS' PRIMARY SCHOOL
SEMESTRAL ASSESSMENT 1
MATHEMATICS (PAPER 2)
PRIMARY 5**

Name: _____ ()

Form class: P5 _____

Math Teacher : _____

Date: 14 May 2019

Duration: 1 h 30 min

INSTRUCTIONS TO CANDIDATES

1. Do not turn over this page until you are told to do so.
2. Follow all instructions carefully.
3. Answer **ALL** questions and show all working clearly.
4. The use of calculator is allowed for this paper.



Questions 1 to 5 carry 2 marks each. Show your working clearly in the space provided for each question and write your answers in the spaces provided.

All diagrams are not drawn to scale. For questions which require units, give your answers in the units stated.

(10 marks)

1. Mary used 1.88 m of cloth to sew a dress. She used 0.9 m less cloth to sew a blouse. How much cloth did Mary need to sew 7 such blouses?

Leave your answer to 1 decimal place.

Ans: _____ m [2]

2. In the figure, ABCD is a rectangle. Find the sum of $\angle x$ and $\angle y$.

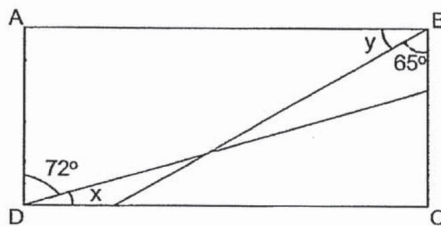

Ans: _____ ° [2]



3. 12 years ago, the ratio of Robin's age to Steve's age to Ted's age was 7 : 3 : 4. Ted is 44 years old now. What was Steve's age 12 years ago?

Ans: _____ [2]

4. The first 14 numbers of a pattern with numbers 1, 3, 7 and 8 are shown below.
1, 3, 7, 8, 1, 3, 7, 8, 1, 3, 7, 8, 1, 3,
What is the sum of the first 312 numbers?

Ans: _____

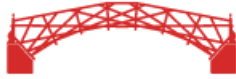

5. A bakery had 150 donuts when it opened for business at 10 a.m. The line graph shows the number of donuts left unsold at the end of each 2-hour period till 8 p.m.

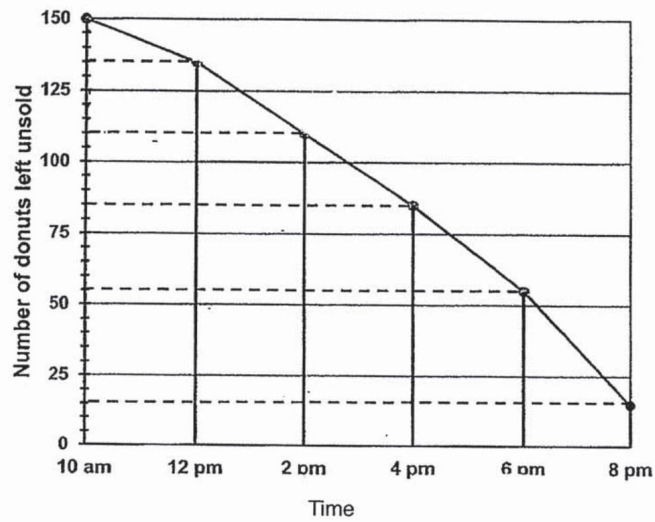

The usual price of each donut was \$2.95. After 8 p.m., all the remaining donuts were sold at \$1.50 each. What was the total amount of money collected from selling all 150 donuts?

Ans: \$ _____ [2]



For questions 6 to 17, show your working clearly in the space provided for each question and write your answers in the spaces provided.
The number of marks available is shown in brackets [] at the end of each question or part-question. All diagrams are not drawn to scale.

(45 marks)

6. ABCD is a rectangle and BEFG is a square. $\angle ABE$ is 138° . Find $\angle CBG$.

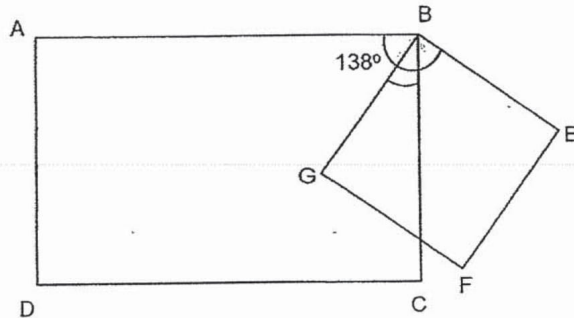

Ans: _____ [3]

7. June bought some chicken and mushroom pies for \$39.60. She bought 7 more mushroom pies than chicken pies. A chicken pie cost \$1.40 while a mushroom pie cost \$0.20 less than the chicken pie. How many chicken pies did June buy?

Ans: _____ [3]



8. There are 106 cars and motorcycles in a car park at a shopping centre. There were 366 wheels altogether. Find the number of motorcycles in the car park.

Ans: _____ [3]

9. A drink stall owner sold $\frac{1}{9}$ of his canned drinks in the morning and $\frac{3}{4}$ of the remaining canned drinks in the afternoon. After he received a delivery of another 200 canned drinks, he found that he had 32 canned drinks more than what he had at first. How many canned drinks did the stall owner have at first?

Ans: _____ [3]



10. Ailing, Bill & Carmen shared a sum of money in the ratio of 4 : 5 : 9. Ailing was given more money by her mother and she had 4 times as much money as before. Bill spent $\frac{2}{5}$ of his money and Carmen spent $\frac{1}{3}$ of her money. The total amount of money the three of them had in the end increased by \$294. What was the total amount of money they had in the end?

Ans: _____ [4]

11. Mrs Lim ordered 460 chocolate and blueberry cupcakes for a birthday party. The chocolate cupcakes were packed in boxes of 6 while the blueberry cupcakes were packed in boxes of 11. The number of boxes of chocolate cupcakes was twice that of the blueberry cupcakes. How many chocolate cupcakes did Mrs Lim buy?

Ans: _____ [3]

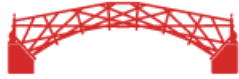

12. Kelvin mixed $1\frac{1}{2}$ ℓ of red paint with $4\frac{1}{3}$ ℓ of yellow paint to make a mixture of orange paint. After he accidentally spilled $\frac{1}{5}$ of the orange paint, he used the remaining orange paint to paint 7 stools. He used $\frac{1}{4}$ ℓ of orange paint for each stool. How much orange paint was left in the end? Give your answer as a mixed number in its simplest form.

Ans: _____ [4]

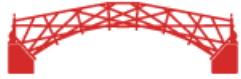

13. PQRS is a rectangle. The length of PQ is three times the length of PU.
The length of TV is 10 cm. Find the total area of the shaded parts.

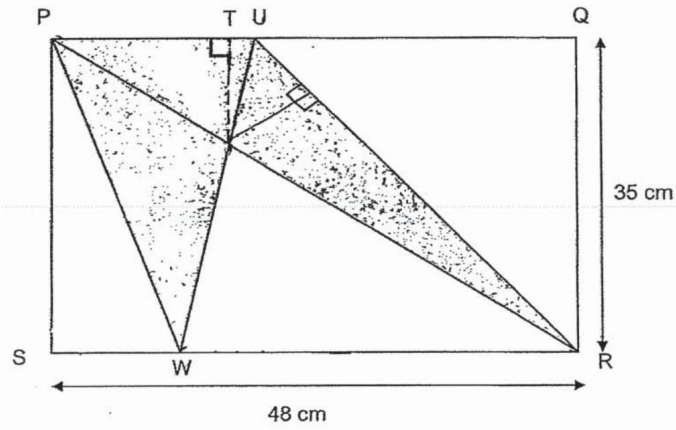

Ans: _____ [4]



14. Container X is $\frac{1}{5}$ filled with water. John pours more water into Container X by using 3 cubical containers of length 11 cm, making Container X to be $\frac{3}{4}$ filled.
- a) Find the capacity of Container X in litres.
- b) How many more litres of water must John pour into Container X to fill it to the brim?

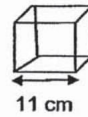
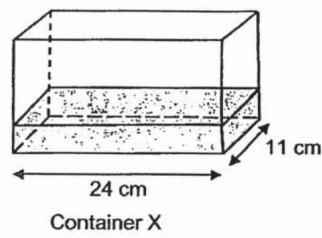

Ans: (a) _____ [2]

(b) _____ [2]

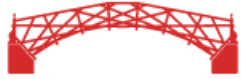

15. $ABCE$ is a square and $EHIJ$ is a rectangle. $HG = GF = FE$. Find the total area of the 2 shaded triangles.

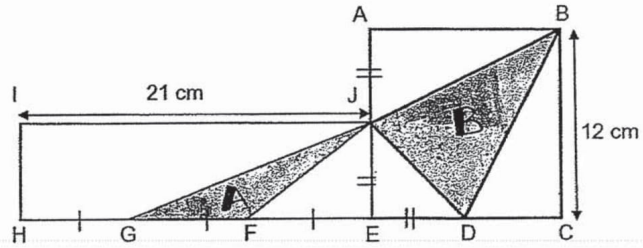

Ans: _____ [4]

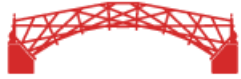

16. 4 blouses and 5 dresses cost \$365. The cost for 3 blouses and 7 dresses was \$433. Jenny decided to buy 4 blouses and some dresses which cost \$512 altogether. How many dresses did she buy?

Ans: _____ [5]



17. Gopal had some \$10-notes, \$5-notes and \$2-notes in the ratio of 11 : 7 : 4. The total value of his \$10-notes was \$3060 more than the total value of his \$2-notes.
- (a) How many \$10-notes did Gopal have at first?
- (b) What was the total value of Gopal's \$2-notes?

Ans: (a) _____ [3]

(b) _____ [2]

End of Paper
☺ Please check your work carefully ☺

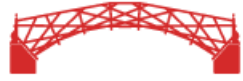

Dr.Kenny Education



ANSWER KEY

YEAR : 2019
LEVEL : PRIMARY 5
SCHOOL : RAFFLES GIRLS' PRIMARY
SUBJECT : MATHEMATICS
TERM : SA 1

PAPER ONE

Q1	2	Q2	2	Q3	4	Q4	1	Q5	4
Q6	4	Q7	2	Q8	3	Q9	2	Q10	3
Q11	3	Q12	2	Q13	2	Q14	3	Q15	4

Q16) 120

Q17) 4.09, 4.106, 40.007, 40.03

Q18) 0.8

Q19)

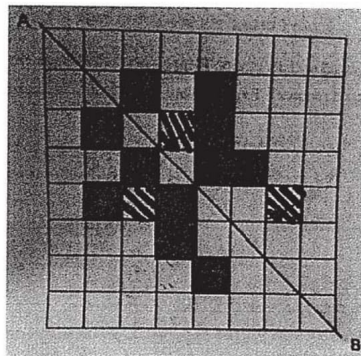

Q20) $\frac{3}{16}$



$$\begin{aligned} \text{Q21) } 10 \div 4 &= \frac{10}{4} \\ &= 2\frac{2}{4} \\ &= 2\frac{1}{2} \end{aligned}$$

Ans: $2\frac{1}{2}$

$$\text{Q22) } 9 \times 8 = \underline{72\text{cm}^3}$$

$$\begin{aligned} \text{Q23) } 2 \text{ rulers} + 9 \text{ pens} &= 21.60 \\ 2 \text{ rulers} + (6 \text{ rulers}) &= 21.60 \\ 8 \text{ rulers} &= 21.60 \\ 1 \text{ ruler} &= 21.60 \div 8 \\ &= \underline{\$2.70} \end{aligned}$$

$$\begin{aligned} \text{Q24) } 105 \div 7 &= 15 \\ 15 \times 4 &= \underline{60 \text{ stamps}} \end{aligned}$$

$$\begin{aligned} \text{Q25) } 310.90 + 99.10 &= 410 \\ 410 \div 5 &= 82 \\ 6 \times 82 &= 492 \\ + 82 &= \underline{\$574} \end{aligned}$$

$$\begin{aligned} \text{Q26) } \frac{1}{2} \times 3 \times 4 &= 6 \\ \frac{1}{2} \times 4 \times 1 &= 2 \\ 6 + 2 &= \underline{8\text{cm}^2} \end{aligned}$$



Q27) Friday $\rightarrow 150 \times 40 = 6000$

Amt on Sat $\rightarrow 17\ 000 - 6000 = 11\ 000$

No of tickets sold $\rightarrow 11\ 000 \div 50 = \underline{220 \text{ tickets}}$

Q28) M : C

68 : 40

44 : 64

11 : 16

Ans: 11:16

Q29) $20 \div 2 = 10$

$20 \times 10 \times 10 = 2000$

$2000 \div 4 = 500$

$500 \times 3 = 1500$

$1500 - 1200 = \underline{300\text{cm}^3}$

Q30) a: False b: Impossible to tell

PAPER TWO

Q1) 1. $0.9 = 0.98$

$0.98 \times 7 = 6.86$

$\approx 6.9\text{m}$

Q2) $90 - 72 = 18$

$90 - 65 = 25$

$25 + 18 = \underline{43^\circ}$



Q3) R : S : T

$$7 : 3 : 8$$

$$44 - 12 = 32$$

$$32 \div 4 = 8$$

$$8 \times 3 = \underline{24}$$

Q4) $1 + 3 + 7 + 8 = 19$ (One group)

$$312 \div 4 = 78$$

$$78 \times 19 = \underline{1482}$$

Q5) $15 + 40 + 65 + 95 = 215$

$$2.95 \times 135 = 398.25$$

$$150 - 15 = 135$$

$$15 \times 1.50 = 22.50$$

$$398.25 + 22.50 = \underline{\$420.75}$$

Q6) $90 + 90 = 180$

$$180 - 138 = \underline{42^\circ}$$

Q7) $1.40 - 0.20 = 1.20$

$$1.20 \times 7 = 8.40$$

$$3000 - 8.40 = 31.20$$

$$3 \div (1.20 + 1.40) = \underline{12 \text{ pies}}$$

Q8) Assume all are cars: $106 \times 4 = 424$

$$424 - 366 = 58$$

$$4 - 2 = 2$$

$$58 \div 2 = \underline{29}$$



Q9) $200 - 32 = 168$

$$168 \div 7 = 24$$

$$24 \times 9 = \underline{216}$$

Q10) A : B : C

$$4 : 5 : 9$$

$$16 : 3 : 6$$

$$25u - 18u = 7u$$

$$7u = 294$$

$$1u = 42$$

$$25 \times 42 = \underline{\$1050}$$

Q11) $6 \times 2 = 12$

$$460 \div 5 = 92$$

$$92 \times 2 = 184$$

$$6 \times 2 = 12$$

$$12 + 11 = 23$$

$$460 \div 23 = 20$$

$$20 \times 12 = \underline{240}$$

Q12) $\frac{4}{5} \times 5\frac{5}{6} = 4\frac{2}{3}$

$$7 - 1 = 7\frac{3}{4}$$

$$4\frac{1}{3} - 1\frac{3}{4} = 3\frac{20}{12} - 1\frac{9}{12}$$

$$= 2\frac{11}{12}$$

Ans: $2\frac{11}{12}$ litres

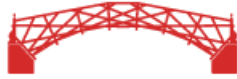

Q13) $48 \div 3 = 16$

$$\frac{1}{2} \times 10 \times 16 = 80$$

$$35 - 10 = 25$$

$$\frac{1}{2} \times 16 \times 35 = 280$$

$$\frac{1}{2} \times 10 \times 16 = 80$$

$$280 + 280 = 560$$

$$560 - 80 = \underline{480\text{cm}^2}$$

Q14a) $11 \times 11 \times 11 = 1331$

$$1331 \times 3 = 3993$$

$$3993 \div 11 = 363$$

$$363 \times 20 = 7260$$

$$= \underline{7.26 \text{ litres}}$$

Q14b) $\frac{3}{4} = \frac{15}{20}$

$$20u - 15u = 5u$$

$$1u = 363$$

$$58 = 363 \times 5$$

$$= \underline{1815 \text{ litres}}$$

Q15) $21 \div 3 = 7$

$$2 = 6$$

$$\frac{1}{2} \times 7 \times 6 = 21$$

$$\frac{1}{2} \times 6 \times 6 = 18$$

$$\frac{1}{2} \times 12 \times 6 = 36$$

$$36 \times 2 = 72$$

$$72 + 18 = 90$$

$$12 \times 12 = 144$$

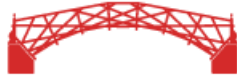

$$144 - 90 = 54$$

$$54 + 21 = \underline{75\text{cm}^2}$$

Q16) (Multiply to common number for dress)

$$28b + 35d = 365 \times 7$$
$$= 2555$$

$$15b + 35d = 433 \times 5$$
$$= 2165$$

(Multiply to common number for blouse)

$$12b + 15d = 365 \times 4$$
$$= 1095$$

$$12b + 28d = 433 \times 4$$
$$= 1732$$

$$1732 - 1095 = 637$$

$$637 \div 13 = 49 \text{ (1d)}$$

$$2555 - 2165 = 390$$

$$390 \div 13 = 30$$

$$30 \times 4 = 120$$

$$512 - 120 = 392$$

$$392 \div 49 = \underline{8 \text{ dresses}}$$

Q17a) $11 \times 10 = 110$

$$7 \times 5 = 35$$

$$^{\wedge} \quad \quad \quad = 8$$

$$- 8 = 102$$

$$3060 \div 102 = 30$$

$$30 \times 11 = \underline{330 \text{ notes}}$$

Q17b) $30 \times 4 \times 2 = \underline{\$240}$

END